



 6000 Lumens

 Cold white

 80° Beam Angle

## GENERAL FEATURES

IP Protection grade	IP68
Installation on	Hull
Dimensions	Ø 130 mm
Mounting hole	Ø 6 mm
Fixing system	screws

## MATERIALS

BODY	STAINLESS STEEL AISI 316L
INTERIOR	RESIN
DIFFUSER	TEMPERATED GLASS
Orientable	No
Flexible	No
Switch	No

## ELECTRICAL SPECIFICATIONS

Type of power	Constant Voltage
Light source	48 high luminosity led
Light Type	One Color
Power supply	60 W
Power consumption	10,5 - 30 Vd
Absorption	2A@12V / 1@24V
Dimmable / Recommended dimmer	No

## PHOTOMETRIC DATA

Color Temperature	cold white (5500 - 6500°K)
Luminous flux typical	6000 lm
Luminous efficacy	125 lm/L
Available light colours	cold white / blue

 Top Beam  
80°

 Side Beam  
80°

## CERTIFICATIONS

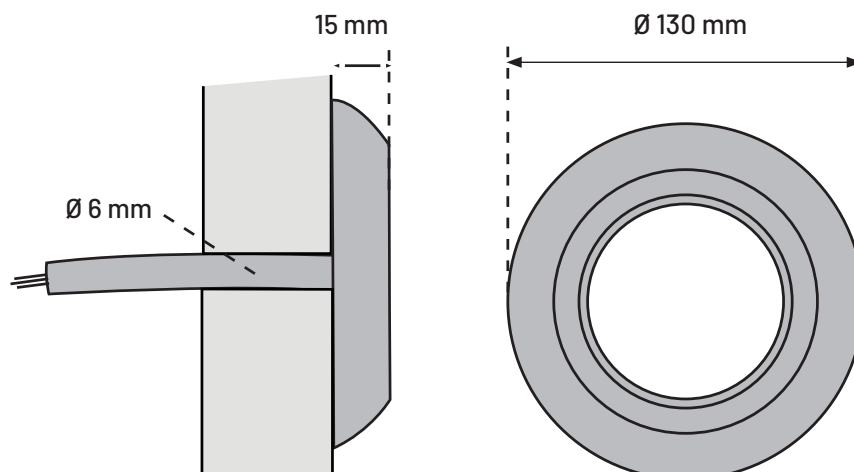

## SPECIFICATION FOR THE CONNECTION OF INDIVIDUAL UNIT

Power	60 W
Power Supply	10,5 - 30 Vdc
Operating Voltage	2A@12V / 1@24V

## CONNECTION INFORMATIONS

### WARNINGS

Use your own supplied power supply.  
Do not connect the appliance directly to the mains (AC).

This product can be connected in parallel.

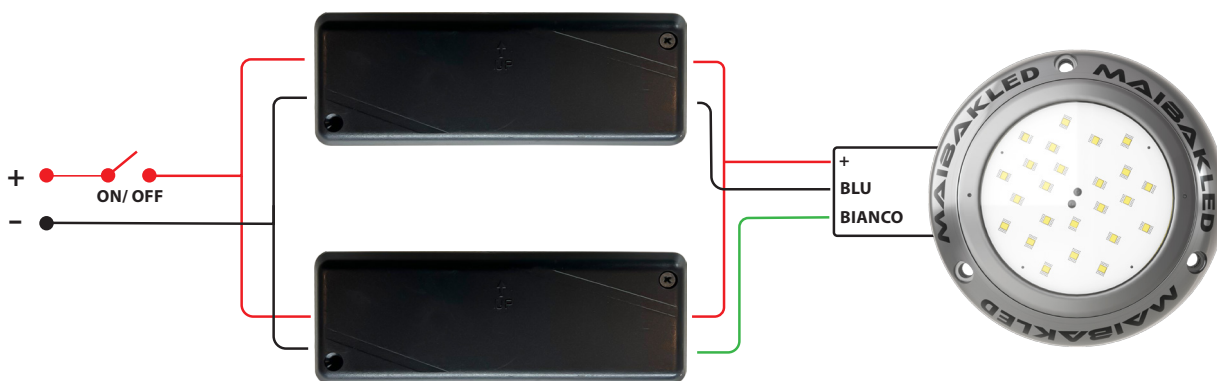

## INSTRUCTIONS FOR ASSEMBLY

- 1 Drill a  $\varnothing$  6mm hole through the hull where the light's center position will be.
- 2 Apply marine grade sealant liberally to the stem and the back perimeter of the light body (as shown in the diagram), as well as around the screw holes.
- 3 Insert the light body into the hull, feeding the stem through first. Press the light into the hull and twist slightly to spread the sealant around evenly behind the light, and then attach the light with fasteners suitable for the type of hull.
- 4 **WARNING:** The lamp should be wired to a zinc hull anode with an electrical cable.
- 5 Paint the metallic frame of the light with a compatible antifouling paint.
- 6 Complete the electrical installation by following the wiring diagram.
- 7 In case of any doubts, contact the dealer or MAIBAKLED.
- 8 Before installing on steel or aluminum boat hulls (in order to avoid galvanic corrosion), contact the dealer or MAIBAKLED.
- 9 Before installing on a cored fiberglass hull, contact the dealer or MAIBAKLED.
- 10 To prevent the LED lights from overheating, do not leave the lights on for more than one minute when they are not submerged in water. (The lights should only be turned on for testing purposes).

